

GLADIATOR

JUNGLE GYMS

Reg. #: CK2003/029269/23, 106 Merriman St, GEORGE, 6539

Cell: 082 453 6284

info@gladiatorjunglegyms.co.za www.gladiatorjunglegyms.co.za



Gladiator Jungle Gyms

PRICELIST

* All timber used is CCA treated, poles are concreted in & metal parts are galvanized

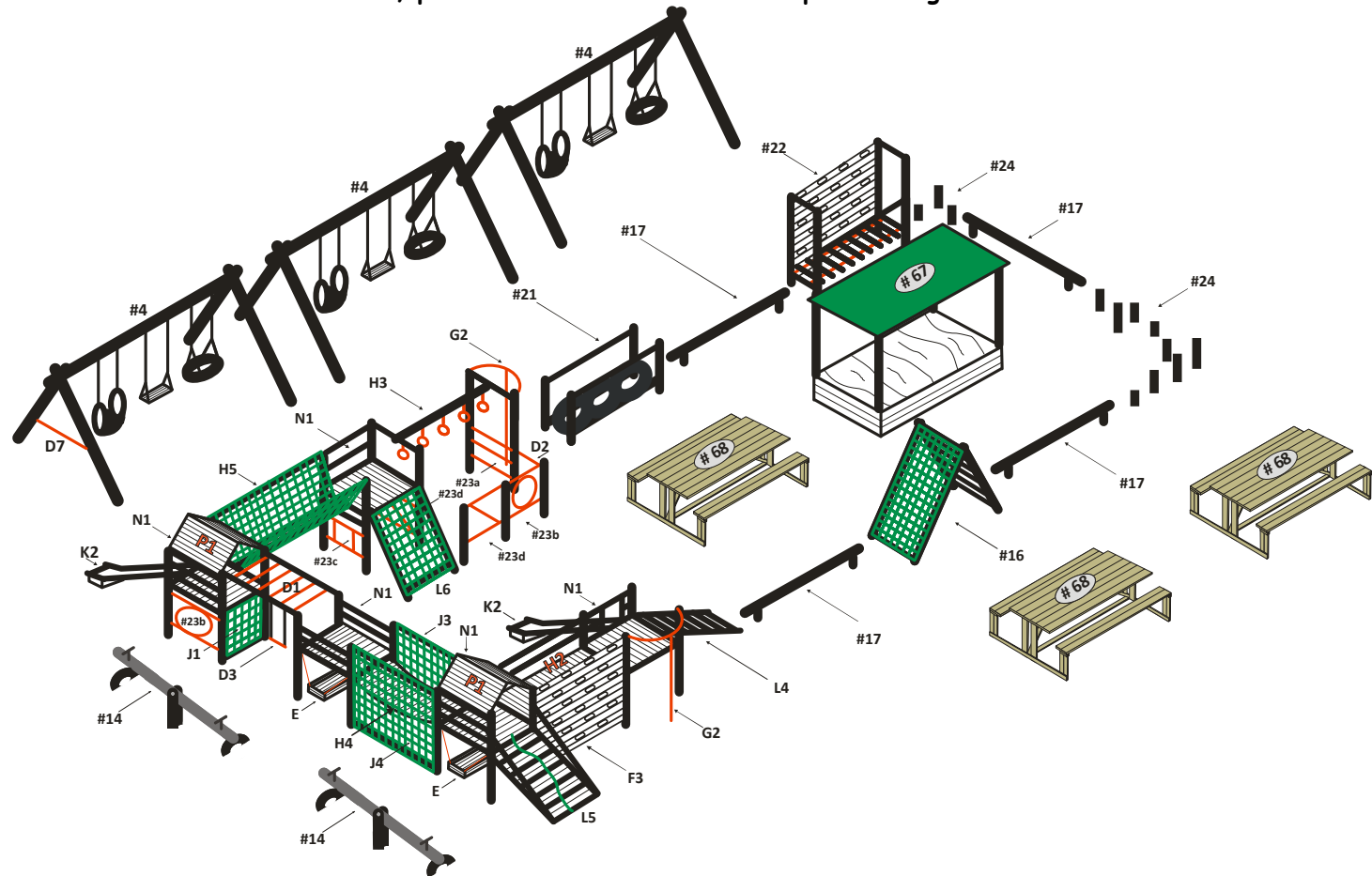

Swings

SINGLE SWING

2
R2 860



DOUBLE SWING

3
R5 640

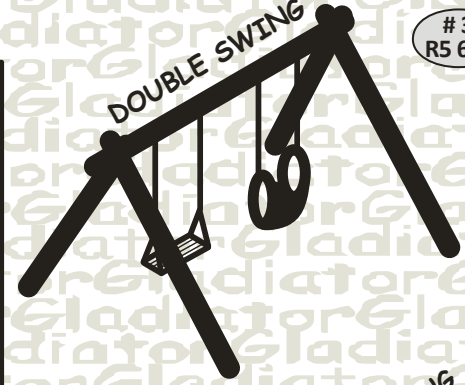

3 Swing seat options

(Sold as individual parts or as a pre-made kit)



C1 - R720 (Full Kit)

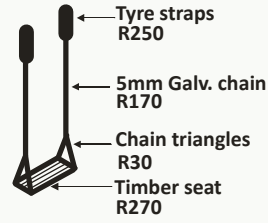

C2 - R720 (Full Kit)

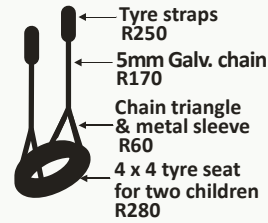

C3 - R760 (Full Kit)

TRIPLE SWING

4
R6 960

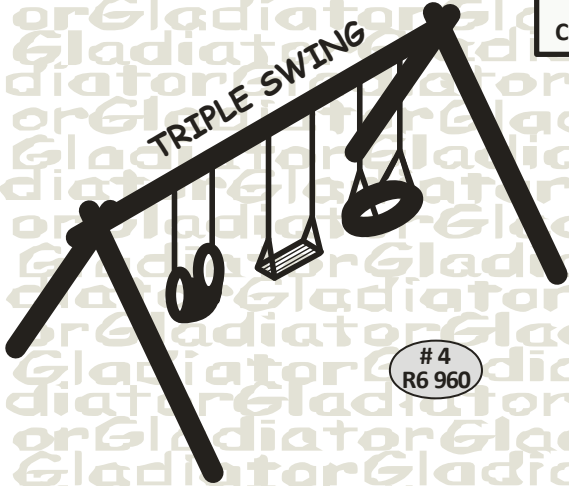

TRIPLE SWING WITH OVERHANG

5
R7 690



Swing / Slide Combos

Prices of slides are not included: 3.3m (K2) - R3 290 & 2.3m (K1) - R2 790



6
R2 600

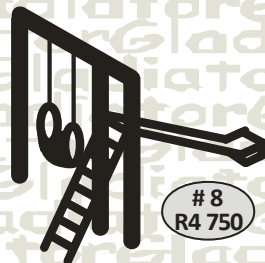

8
R4 750

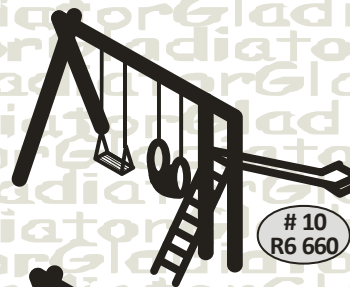

10
R6 660

12
R10 920



7
R3 300

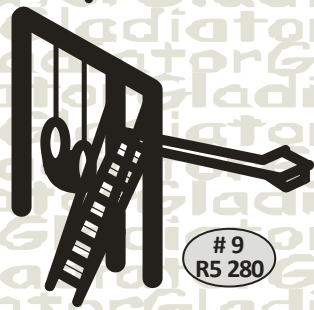

9
R5 280

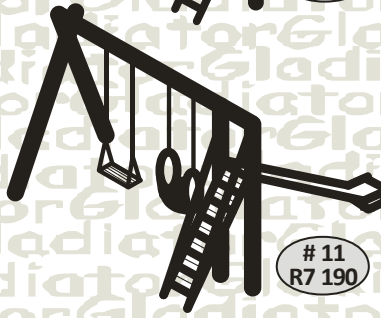

11
R7 190

13
R11 450



Obstacles

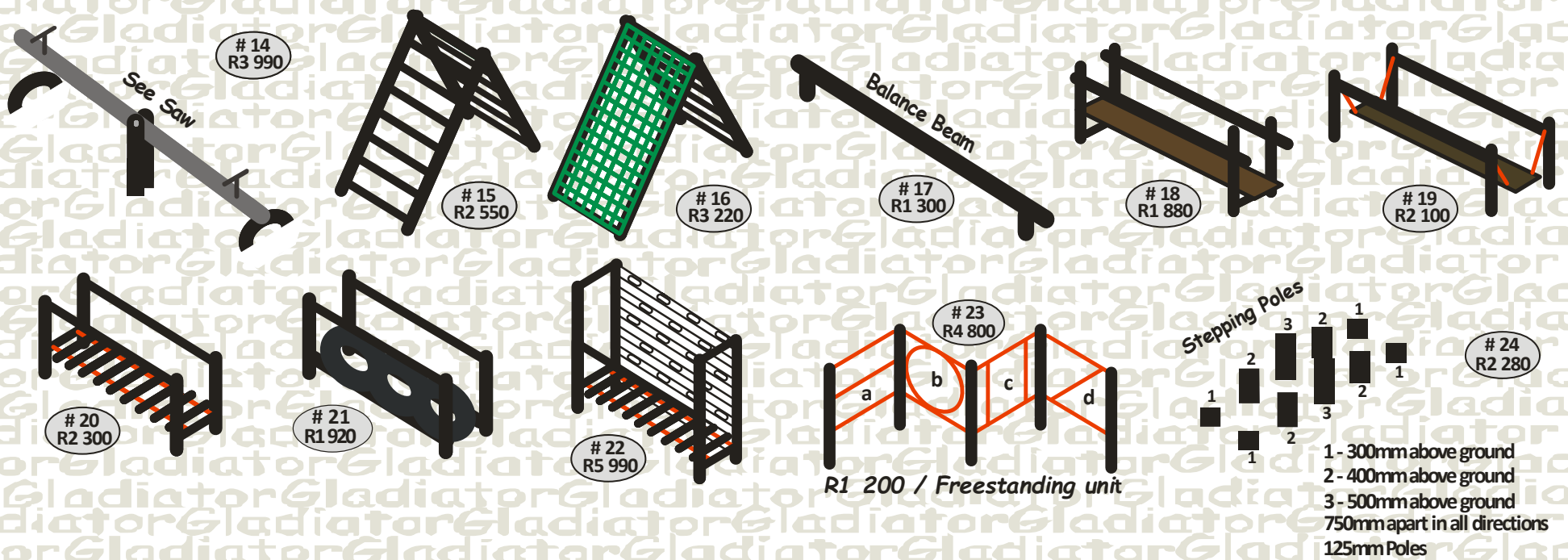

Jungle Gyms - Design It Yourself

Simply add the item required or take away the unwanted

DESIGN YOUR OWN

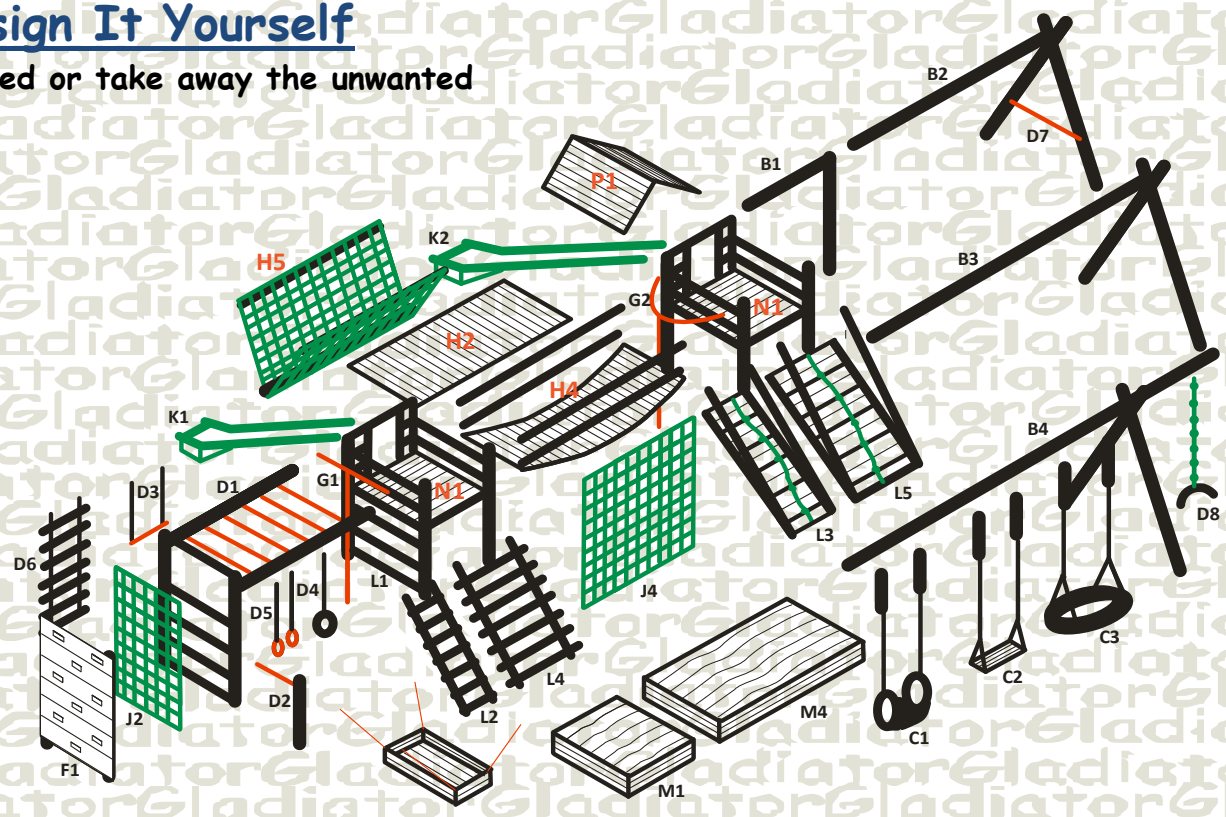

Prices of slides are not included: 3.3m (K2) - R3 290 & 2.3m (K1) - R2 790



Prices of slides are not included: 3.3m (K2) - R3 290 & 2.3m (K1) - R2 790

37
R16 645

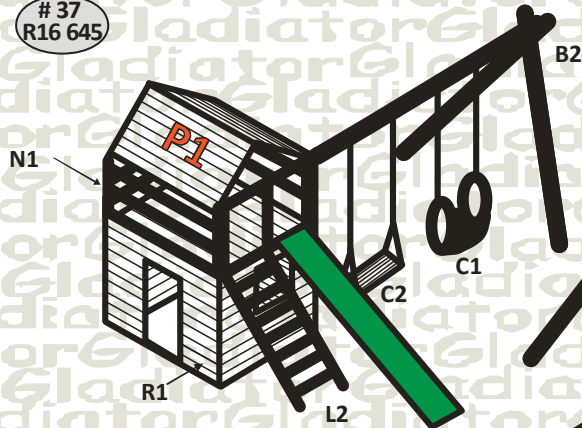

Windows & door optional
(not included in price)

38
R23 895

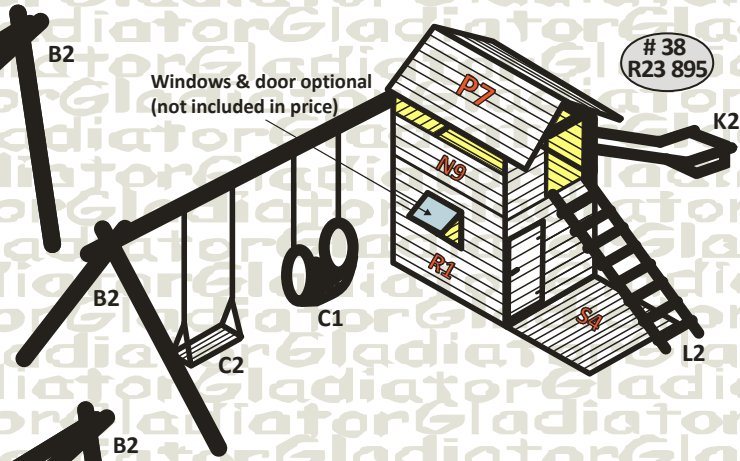

39
R25 935

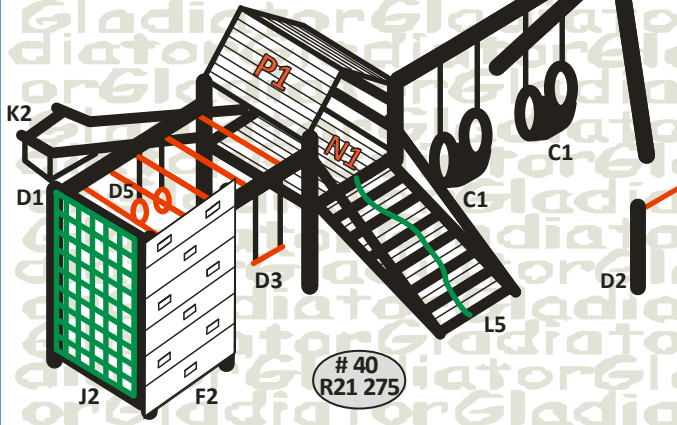
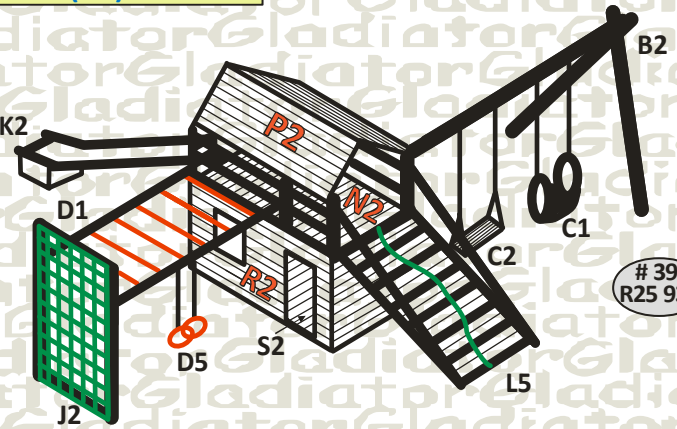

40
R21 275

41
R27 285

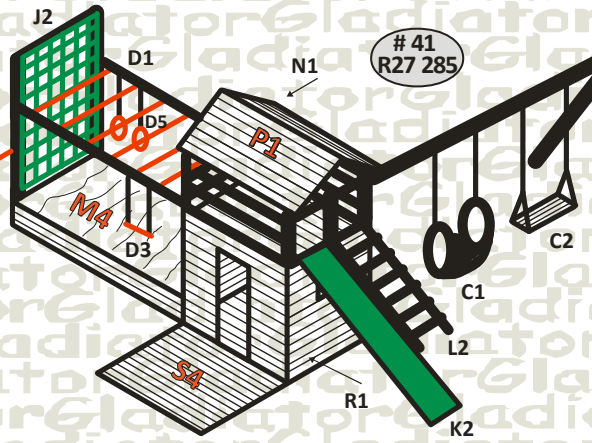

42
R21 775

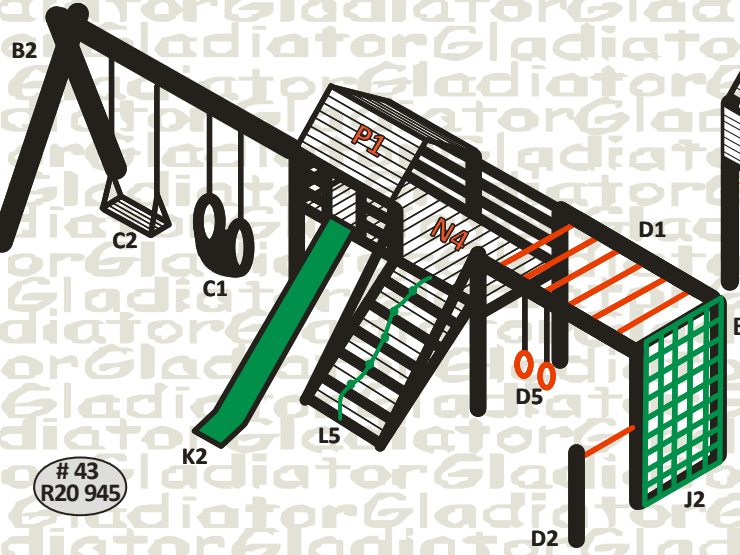
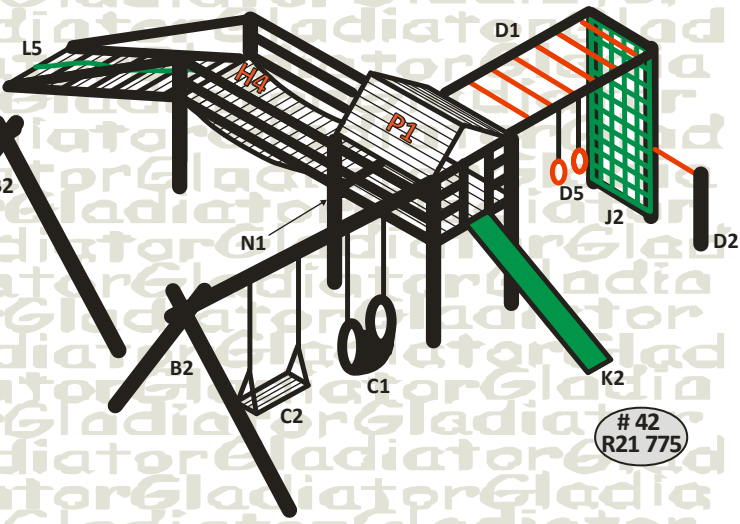

43
R20 945

44
R19 990

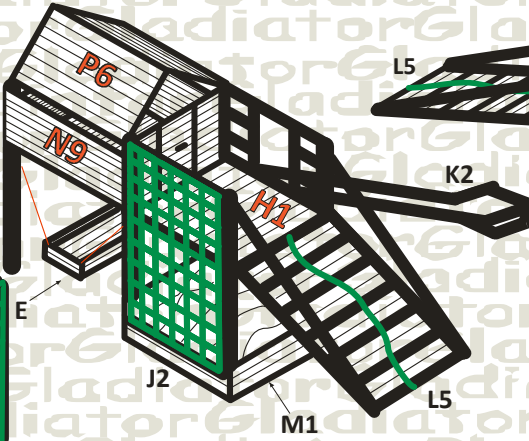

45
R27 465

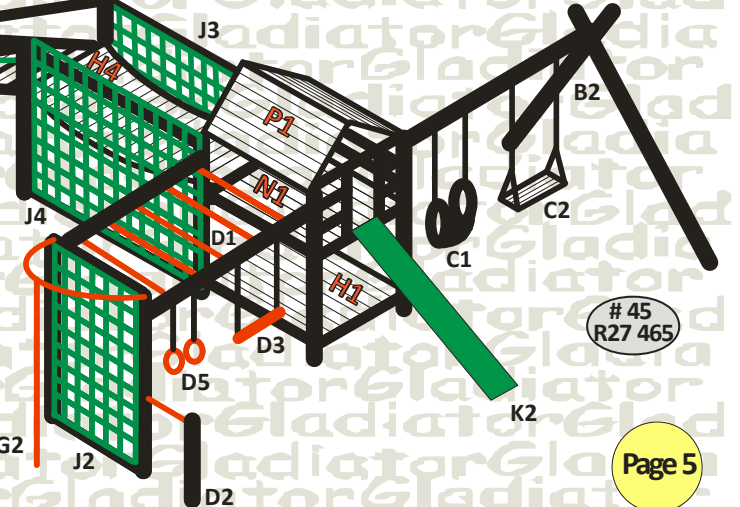

Prices of slides are not included: 3.3m (K2) - R3 290 & 2.3m (K1) - R2 790



#46
R31 325

#47
R27 695

#48
R29 190

#49
R37 635

#50
R23 665

#51
R32 020

Prices of slides are not included: 3.3m (K2) - R3 290 & 2.3m (K1) - R2 790

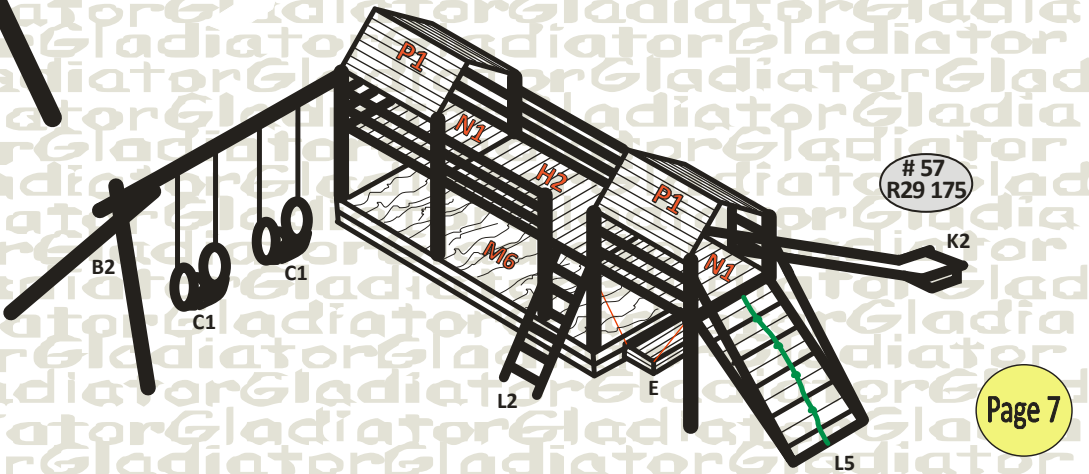
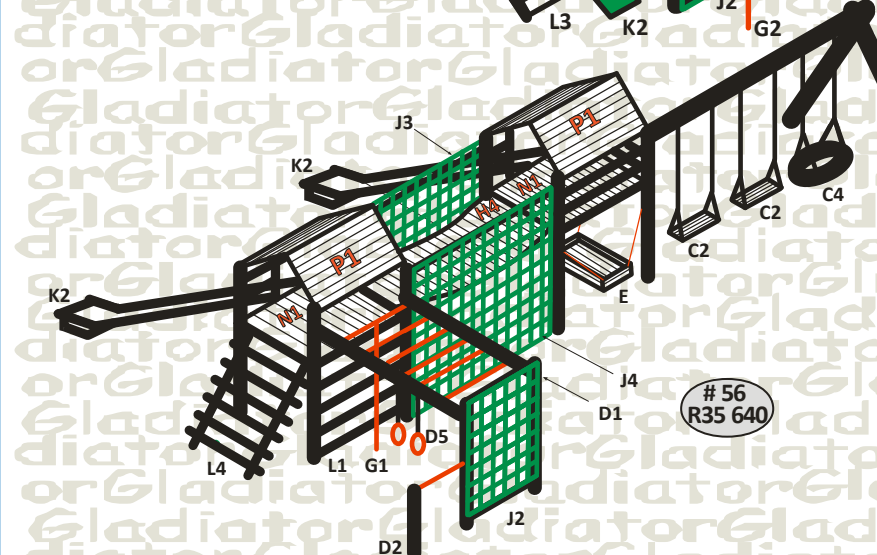
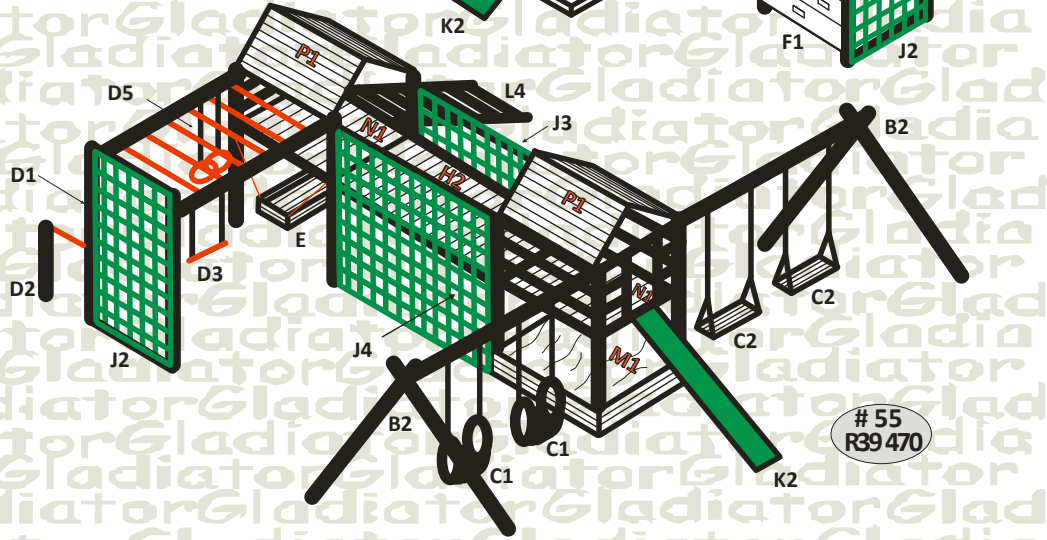
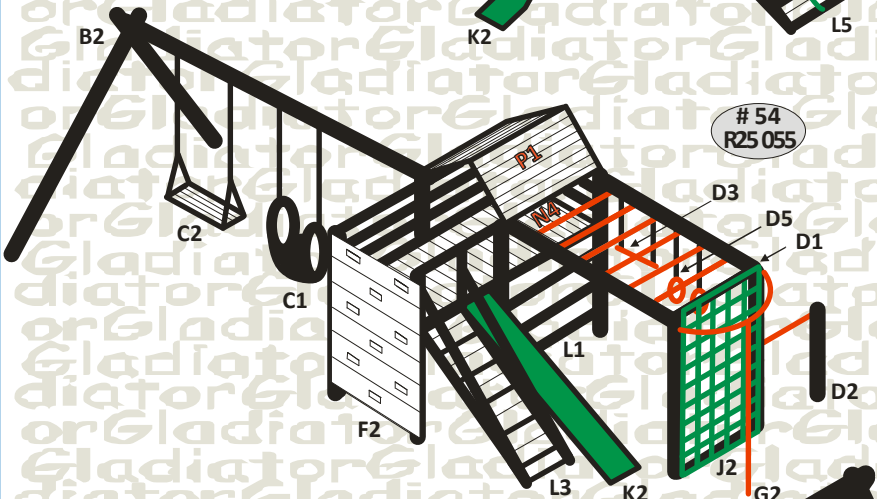
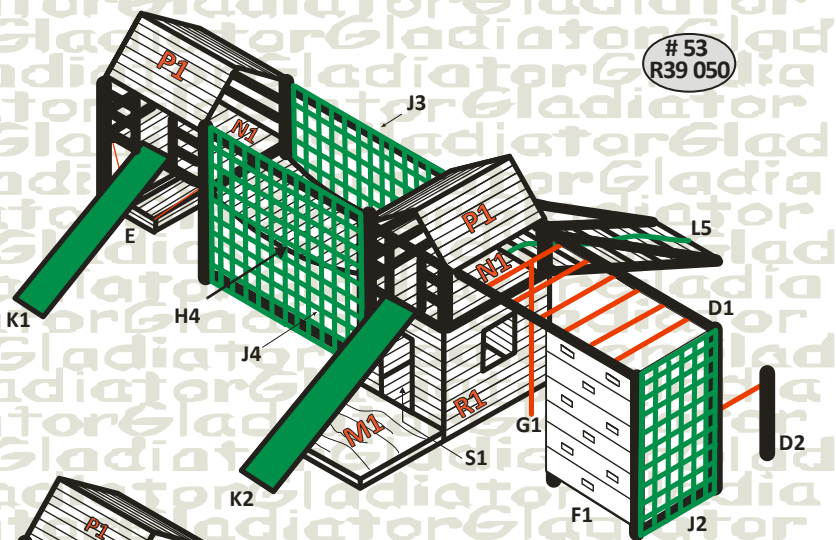
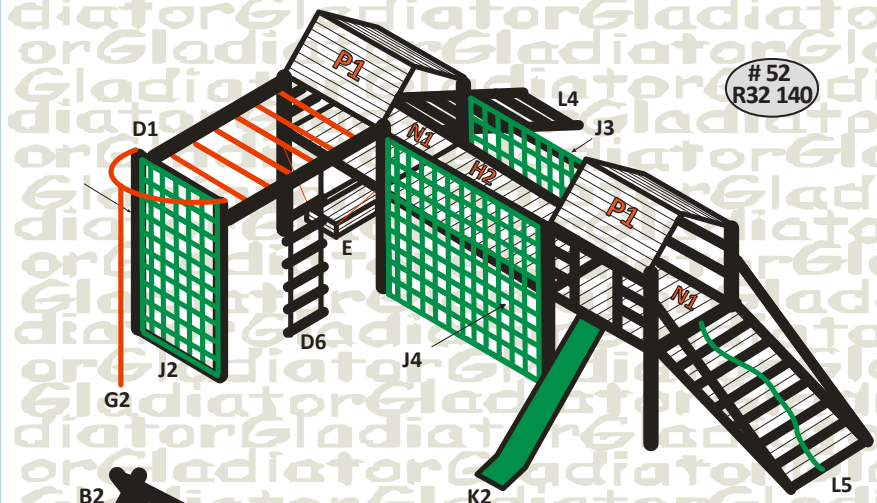

Prices of slides are not included: 3.3m (K2) - R3 290 & 2.3m (K1) - R2 790



58
R53 730

59
R54 050

60
R44 145

61
R40 670

Prices of slides are not included: 3.3m (K2) - R3 290 & 2.3m (K1) - R2 790

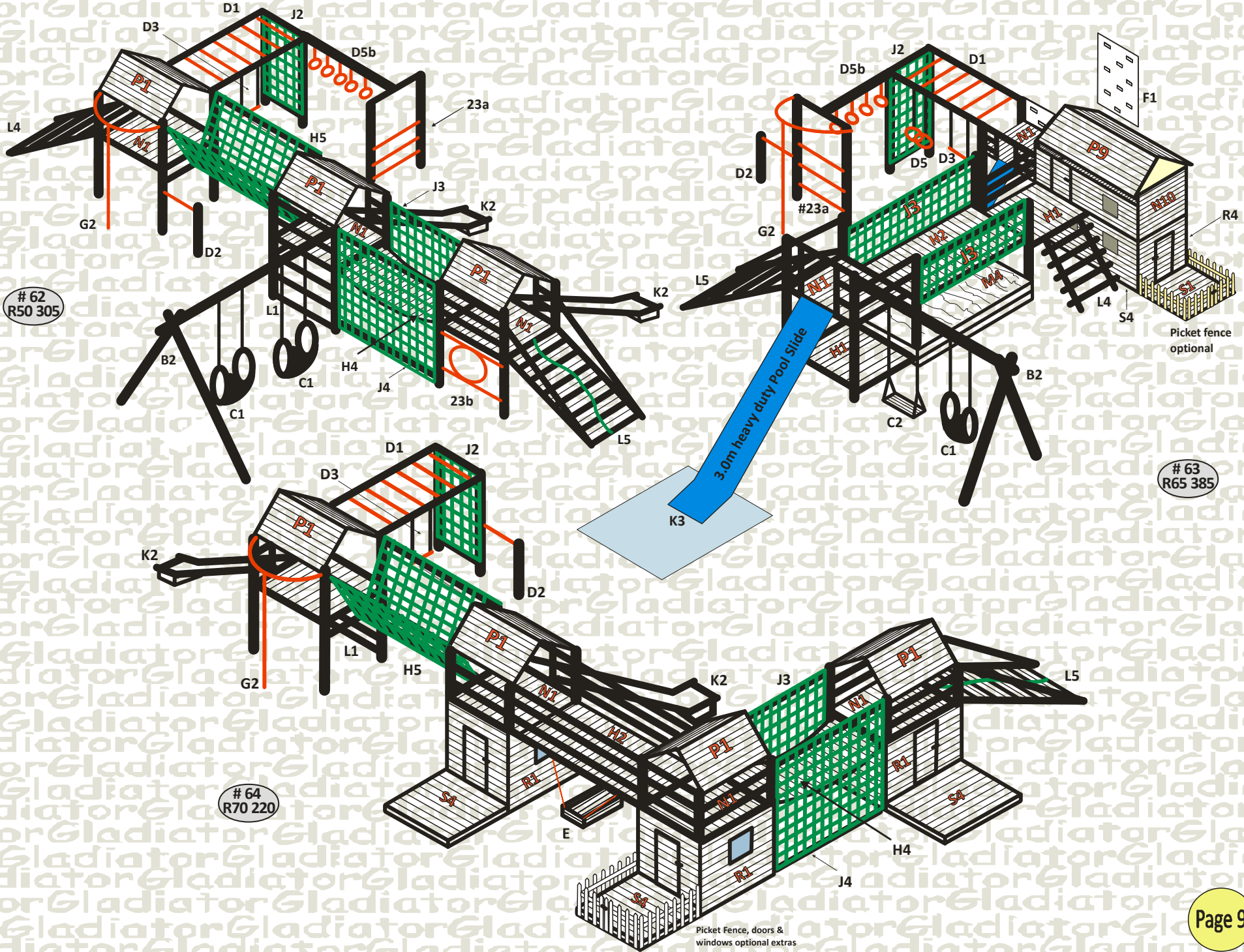

62
R50 305

63
R65 385

64
R70 220

Picket Fence, doors & windows optional extras

Prices of slides are not included: 3.3m (K2) - R3 290 & 2.3m (K1) - R2 790

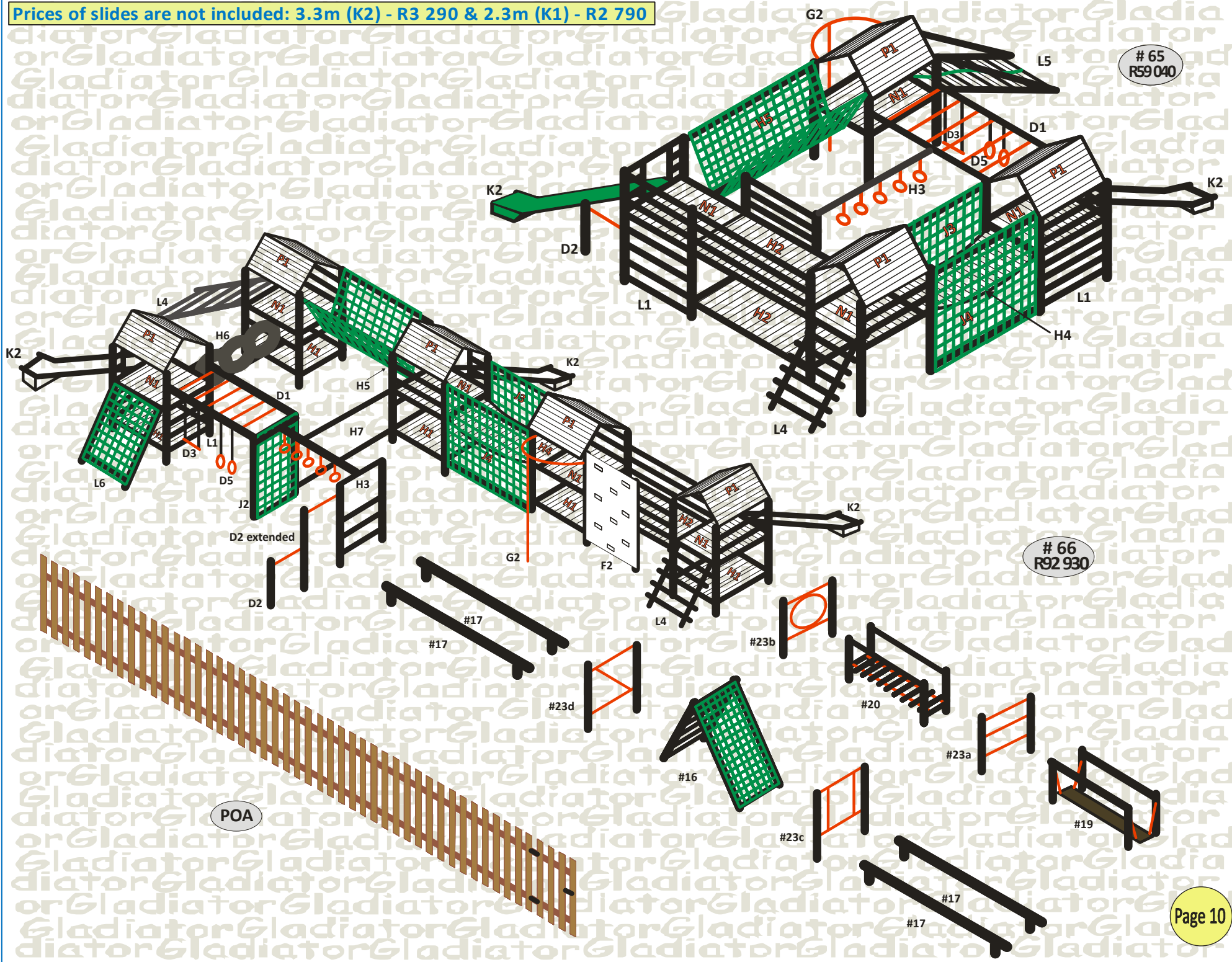

65
R59 040

66
R92 930

POA

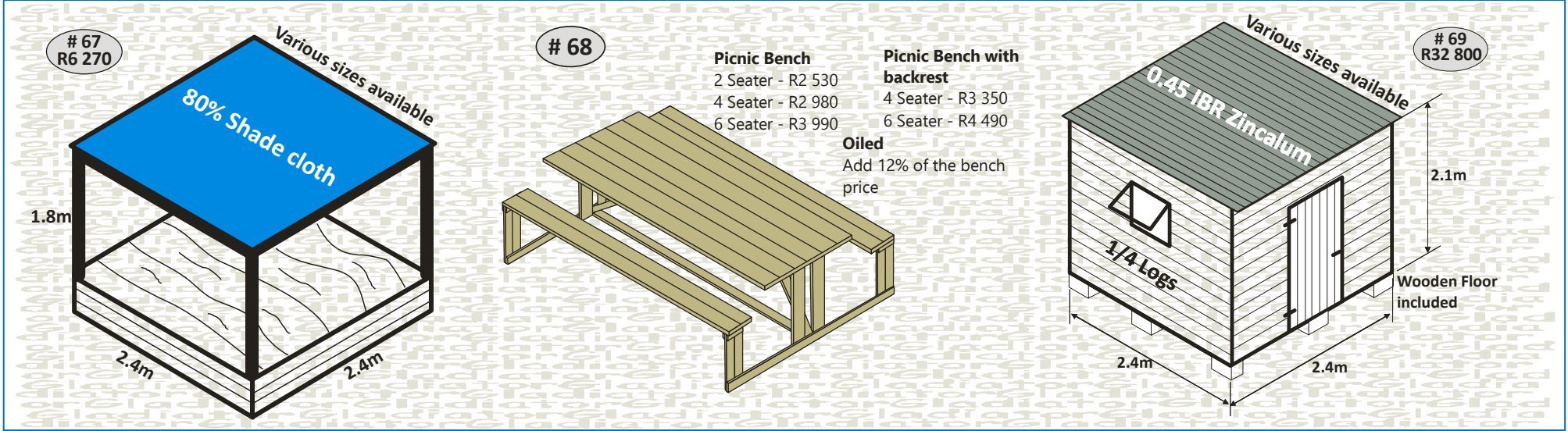

Individually Priced Items

No.	Description	Price/unit
B1	Single swing structure	R1 825
B2	Double swing structure	R3 175
B3	Triple swing structure	R3 780
B4	Triple swing structure with overhang	R3 995
C1	Cut tyre swing set (includes seat, rubber strap & chains)	R720
C2	Timber swing set (includes seat, rubber strap & chains)	R720
C3	Doughnut two seater swing (includes seat, rubber strap & chains)	R760
D1	Monkey bar	R2 730
D2	Somersault bar - as part of jungle gym	R780
D2b	Extended Somersault bar - as part of jungle gym	R1 150
D3	Belly swing kit	R580
D4	Monkey swing kit	R520
D5	Monkey rings kit - 2 rings	R580
D5b	Monkey rings as apparatus	R2 890
D6	Chain ladder - rope ladder	R920
D7	Tumble bar	R490

No.	Description	Price/unit
D8	Knotted rope with tyre as part of apparatus	R390
E	Rocker boat	R1 890
F1	Climbing wall 1,2x1,8m	R2 100
F2	Climbing wall 1,2x2,4m	R2 680
F3	Climbing wall 2,4x2,4m	R5 100
G1	Fireman's pole as part of monkey bar - integrated	R740
G2	Fireman's pole as part of jungle gym - half circle shape	R1 310
H1	Solid timber bridge - 1,2x1,2m	R1 150
H2	Solid timber bridge - 1,2x2,4m	R2 270
H3	Monkey rings as apparatus	R2 890
H4	Suspension chain bridge	R2 980
H5	V-shape net bridge, cargo net included	R2 980
H6	Tyre bridge	R1 920
H7	Pirate bridge	R1 180

No.	Description	Price/unit
J1	Cargo net 1,2x1,5m	R880
J2	Cargo net 1,2x1,8m	R990
J3	Cargo net 1,2x2,2m	R1 150
J4	Cargo net 2,2x2,2m	R2 220
K1	Slide 2,3m long	R2 790
K2	Slide 3,3m long	R3 290
K3	Heavy duty, wide pool slide 3m	R5 100
L1	Vertical ladder	R440
L2	Narrow ladder	R700
L3	Narrow solid ramp with handrails & knotted anchor rope	R1 240
L4	Standard wide ladder	R1 240
L5	Solid wide ramp with handrails & knotted anchor rope	R2 140
L6	Netted wide ladder	R1 850
M1	Sandpit - lined & filled (1,2x1,2) x 0,3 deep	R1 890
M2	Sandpit - lined & filled (1,2x1,8) x 0,3 deep	R2 020
M3	Sandpit - lined & filled (1,2x2,1) x 0,3 deep	R2 250
M4	Sandpit - lined & filled (1,2x2,4) x 0,3 deep	R2 710
M5	Sandpit - lined & filled (1,2x3,0) x 0,3 deep	R3 170
M6	Sandpit - lined & filled (1,2x3,6) x 0,3 deep	R3 640
M7	Sandpit - lined & filled (1,8x1,8) x 0,3 deep	R3 050
M8	Sandpit - lined & filled (2,4x2,4) x 0,3 deep	R3 860
M9	Sandpit - lined & filled (3,0x3,0) x 0,3 deep	R7 100
N1	Den (1,2x1,2) - safety rails and safety T bar at entrance to slide	R5 170
N2	Den (1,2x1,8) - safety rails and safety T bar at entrance to slide	R5 830
N3	Den (1,2x2,1) - safety rails and safety T bar at entrance to slide	R6 590
N4	Den (1,2x2,4) - safety rails and safety T bar at entrance to slide	R7 320
N5	Den (1,2x3,0) - safety rails and safety T bar at entrance to slide	R8 810
N6	Den (1,2x3,6) - safety rails and safety T bar at entrance to slide	R9 560

No.	Description	Price/unit
N7	Den (1,8x1,8) - safety rails and safety T bar at entrance to slide	R7 320
N8	Den (2,4x2,4) - safety rails and safety T bar at entrance to slide	R8 810
N9	Den - fully enclosed sides with door (1,2x1,2)	R9 560
N10	Den - fully enclosed sides with door (1,2x1,8)	R10 180
P1	Roof with standard decking timber (1,2x1,2)	R1 790
P2	Roof with standard decking timber (1,2x1,8)	R2 110
P3	Roof with standard decking timber (1,2x2,1)	R2 250
P4	Roof with standard decking timber (1,2x2,4)	R3 660
P5	Roof with standard decking timber (1,8x1,8)	R4 270
P6	Roof with weatherboard / 1/4 log timber (1,2x1,2)	R2 070
P7	Roof with weatherboard / 1/4 log timber (1,2x1,8)	R2 380
P8	Roof with weatherboard / 1/4 log timber (1,2x2,1)	R2 510
P9	Roof with weatherboard / 1/4 log timber (1,2x2,4)	R3 900
P10	Roof with weatherboard / 1/4 log timber (1,8x1,8)	R4 530
R 1	Wendy house below den (1,2x1,2) - 3 window & 1 door opening	R4 370
R 2	Wendy house below den (1,2x1,8) - 3 window & 1 door opening	R5 380
R 3	Wendy house below den (1,2x2,1) - 3 window & 1 door opening	R6 020
R 4	Wendy house below den (1,2x2,4) - 3 window & 1 door opening	R6 820
R 5	Wendy house below den (1,8x1,8) - 3 window & 1 door opening	R8 550
R 6	Wendy house below den (2,4x2,4) - 3 window & 1 door opening	R11 240
S1	Wendy house timber floor (1,2x1,2)	R1 150
S2	Wendy house timber floor (1,2x1,8)	R1 560
S3	Wendy house timber floor (1,2x2,1)	R1 860
S4	Wendy house timber floor (1,2x2,4)	R2 270
S5	Wendy house timber floor (1,8x1,8)	R2 500
S6	Wendy house timber floor (2,4x2,4)	R4 470

Guarantee

An advertisement board (125mm x 300mm) will be displayed on all installations which will serve as a 2 year Workmanship Guarantee.

Any combinations or own designs are welcome!

INSTALLATION & DELIVERY INFORMATION

Please note that we have a R8.90 per kilometer return trip delivery and installation fee outside George. Installations in George are as indicated on the pricelist.

Delivery & installation fees will be indicated on each quotation depending on the estimated duration to complete installation.

Installation Fees:

George	No Charge
Jeffreys Bay	R4 448
Beaufort West	R4 060
Ladismith	R2 847
Riversdale	R2 210
Stillbay	R2 310
Plettenberg bay	R1 690
Calitzdorp	R2 100

Albertinia	R1 600
Knysna	R1 220
Mossel bay	R955
Oudtshoorn	R955
Hartenbos	R890
Sedgefield	R710
Little Brak	R580
Great Brak	R465

Please Note:

Quotations of own designs, painting & oiling, combinations, repairs and maintenance will be quoted for separately. Please note that the following services are not included in our prices and can be quoted for if required:

Tree removal / Landscaping / Washing lines, etc. (Please notify, at point of order, if these obstacles need to be removed in order to install a structure)

We don't have any guarantee on paintwork or oiling of jungle gyms.

We require a 50% deposit to place an order. We operate on a first come first served basis. The lead-time is normally 5 to 10 working days from when the deposit is received.

Terms & conditions of PAYMENT

- 50% of total on acceptance of quote (to place an order)
- 50% of total on completion (Which covers all materials used. All material used on site remains to be the property of Gladiator Jungle Gyms until such time of final payment)
- Settlement after paying the deposit is due on the day of completion without any exceptions.
- Interest at a rate of prime plus 2% will be added to any balance outstanding after due date.
- Outstanding debts are automatically handed over to debt collectors if not settled within one calendar month and the costs thereof will be for the debtors account.
- A detailed invoice will be generated on request.

We also install: Decks

Fences

Carports

Wendy Houses

Boardwalks

"Big and small, we do them all!"

Important Notice: All diagrams have been specifically developed and designed by Gladiator Jungle Gyms and belong exclusively to the Company. Any design copied or adapted by another person and/or contractor will be seen as plagiarism and legal steps will be taken.

GLADIATOR JUNGLE GYMS CANNOT BE HELD RESPONSIBLE FOR ANY INJURIES THAT MAY BE SUSTAINED DURING ACTIVITIES WHILST USING PLAYGROUND EQUIPMENT